

Broil King®

ASSEMBLY MANUAL & PARTS LIST - MANUEL DE MONTAGE & LISTE DE PIÈCES - MANUAL DE ARMADO Y LISTA DE PARTES

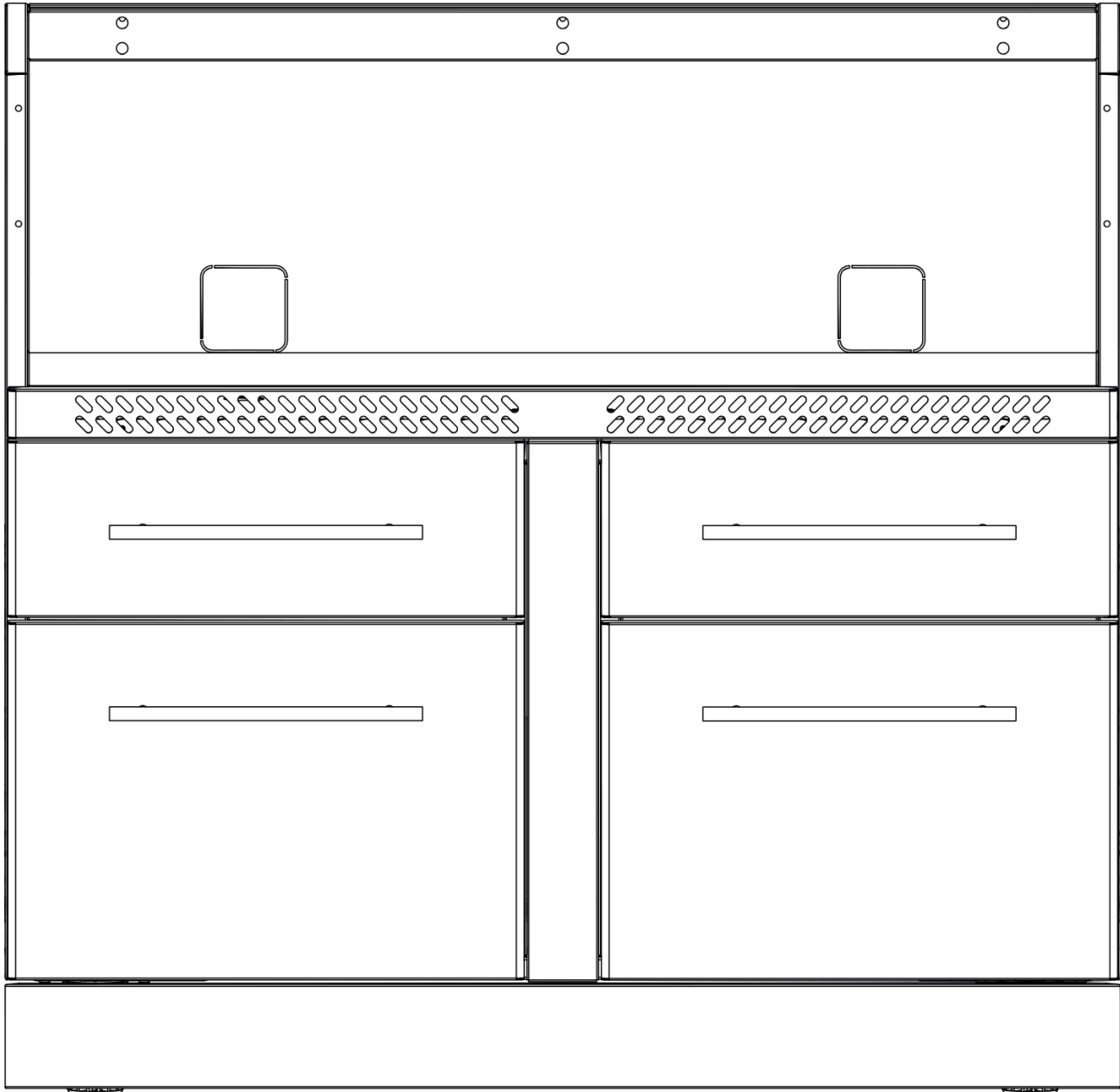

Broil King
806600

RETAIN FOR FUTURE REFERENCE - VEUILLEZ CONSERVER POUR REFERENCE ULTERIEURE - CONSERVAR PARA FUTURAS CONSULTAS

Onward
SINCE 1906
MANUFACTURING COMPANY
585 KUMPF DRIVE LIMITED
WATERLOO, ONTARIO, CANADA
N2V 1K3

70084-E65 REV A 04/20

1

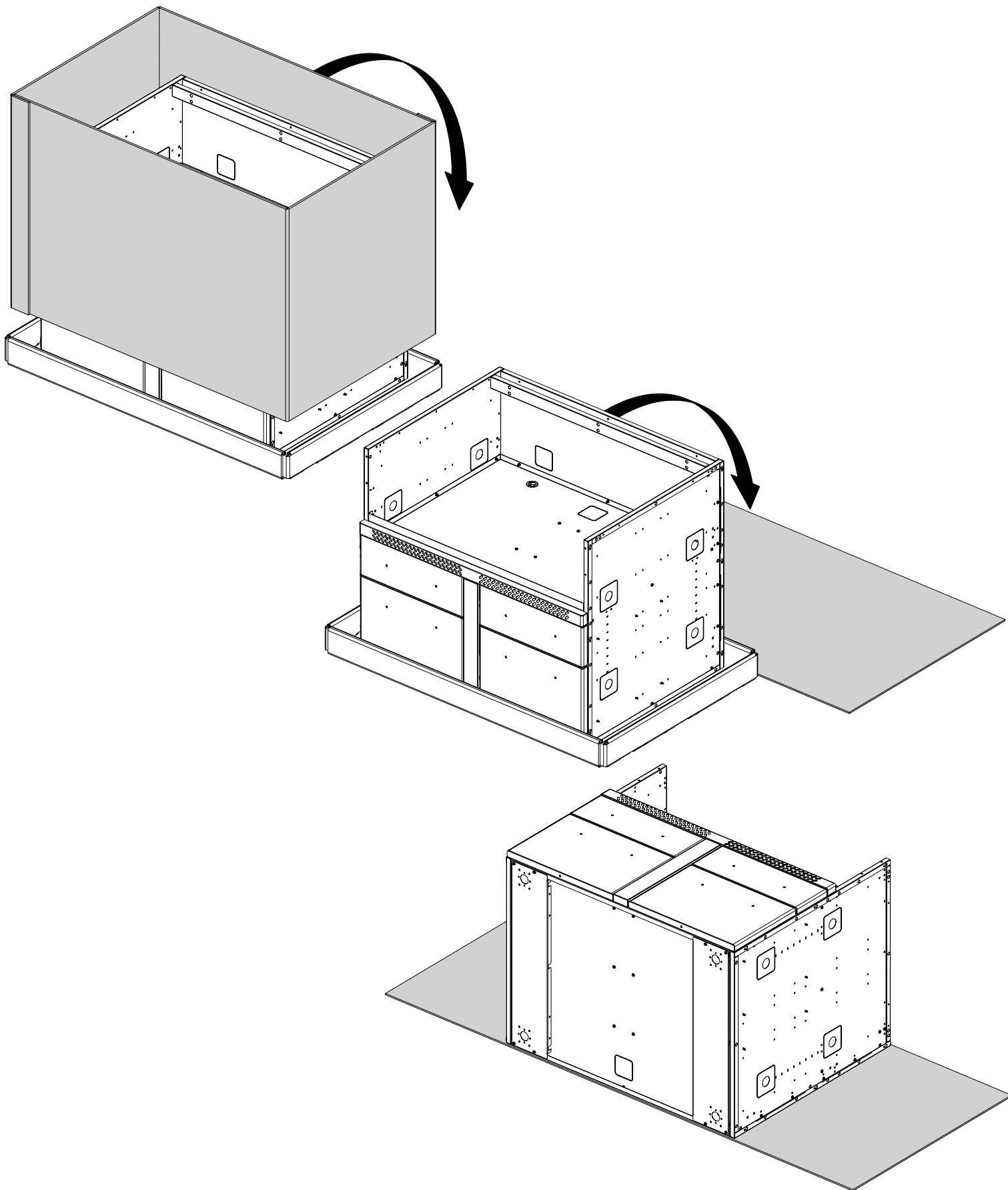

2

(16) 

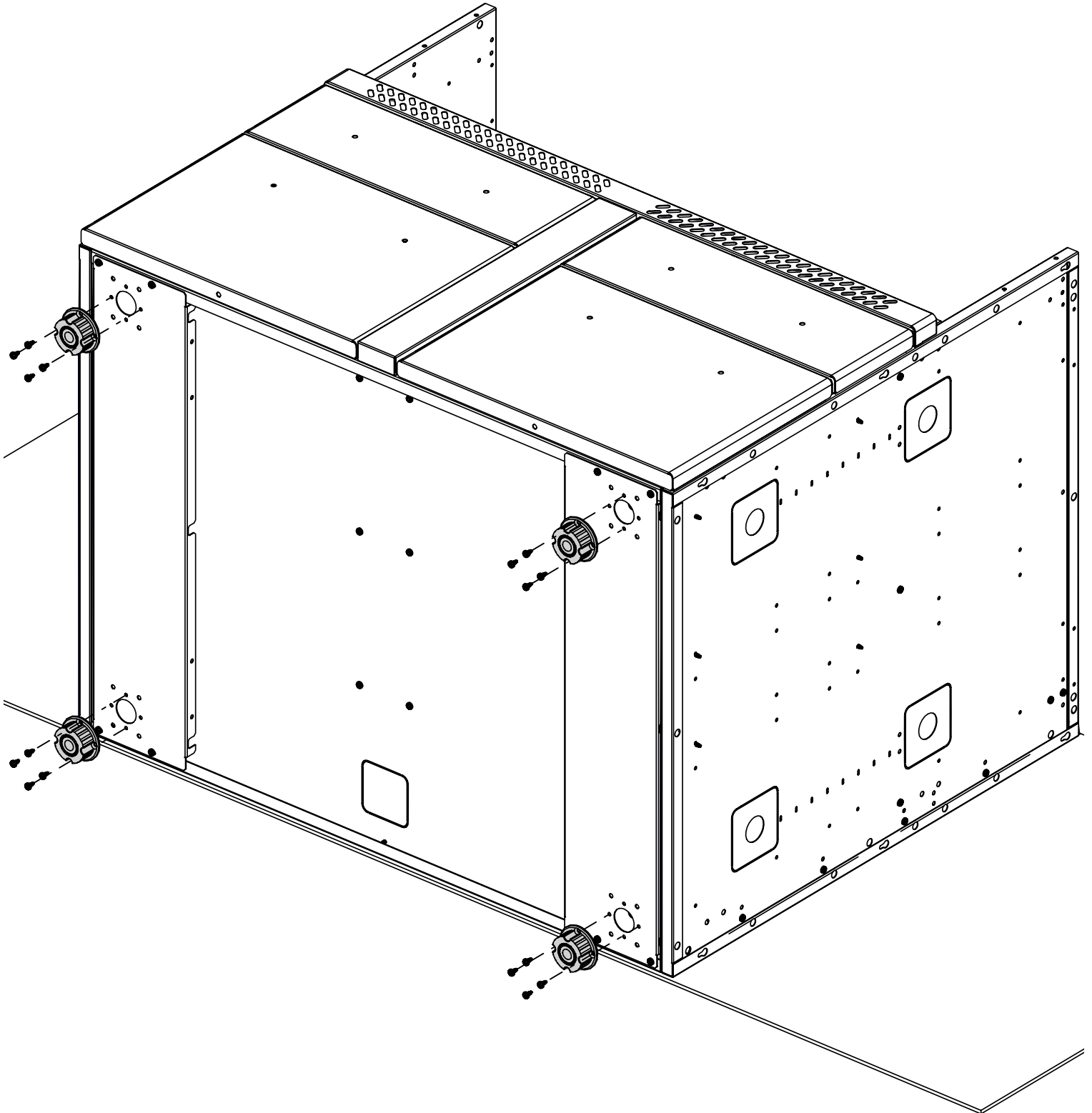

3

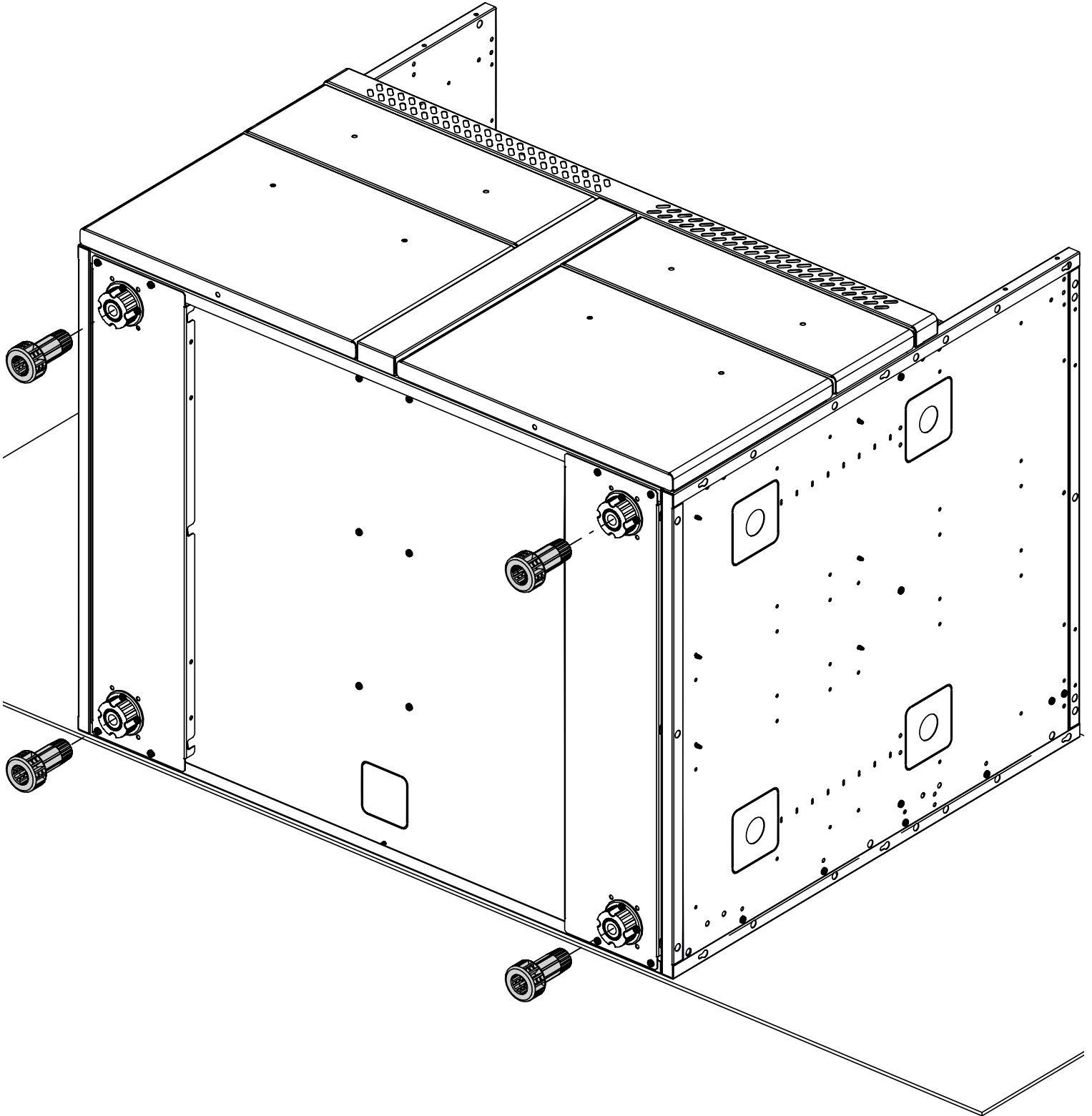

4

(8)

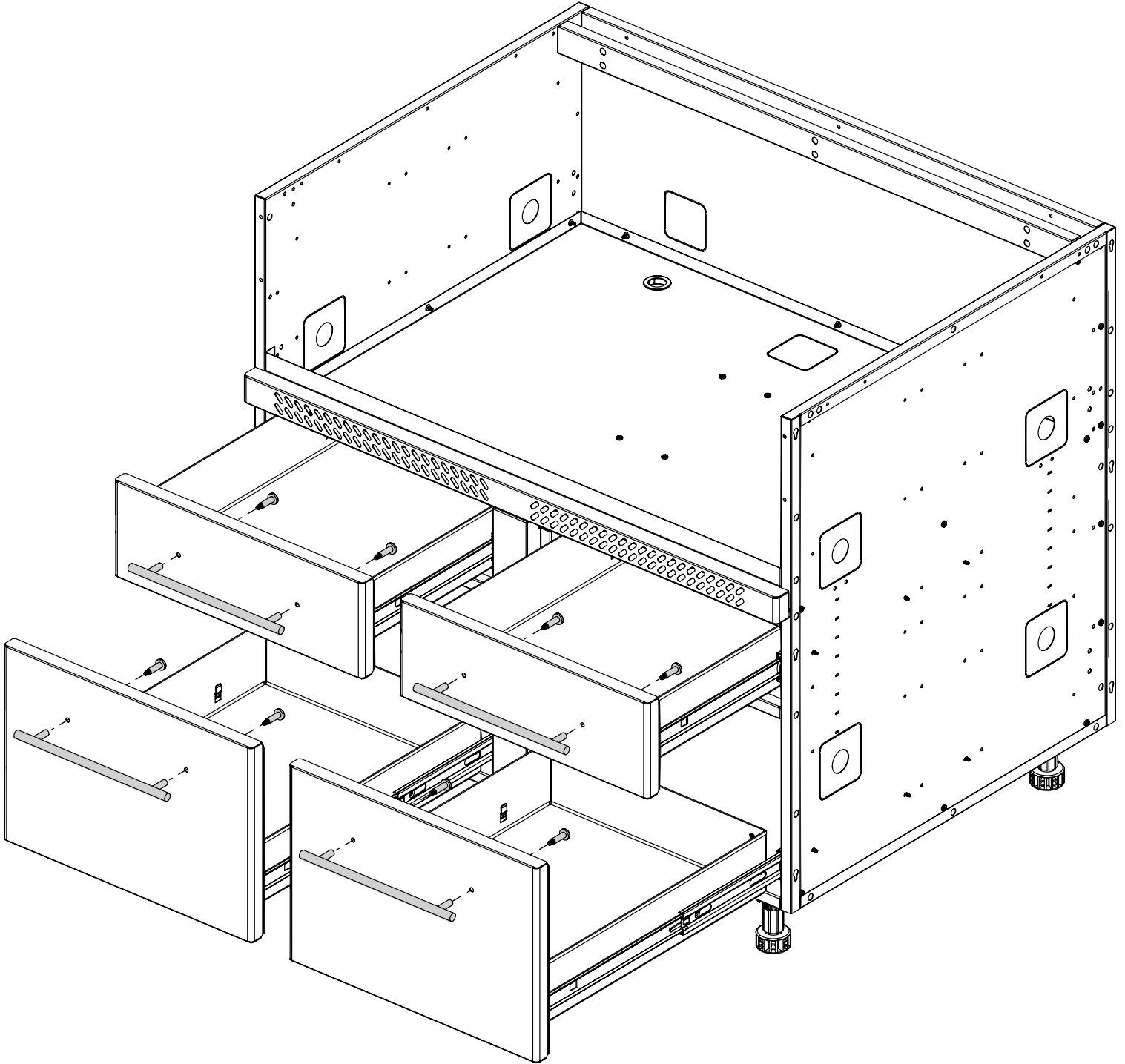
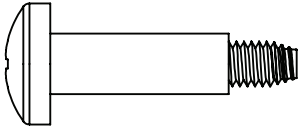

5

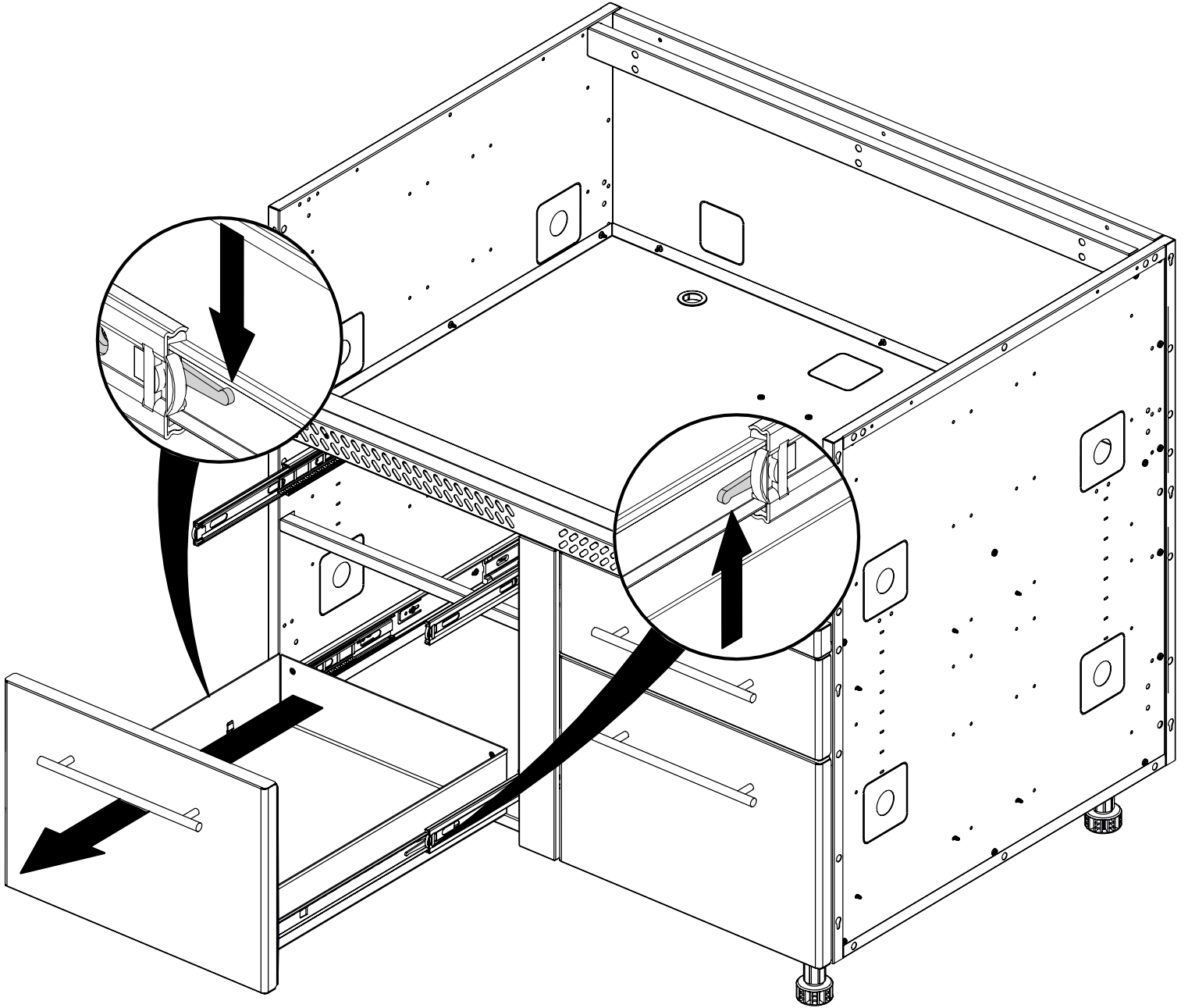

6

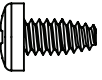
(1) 

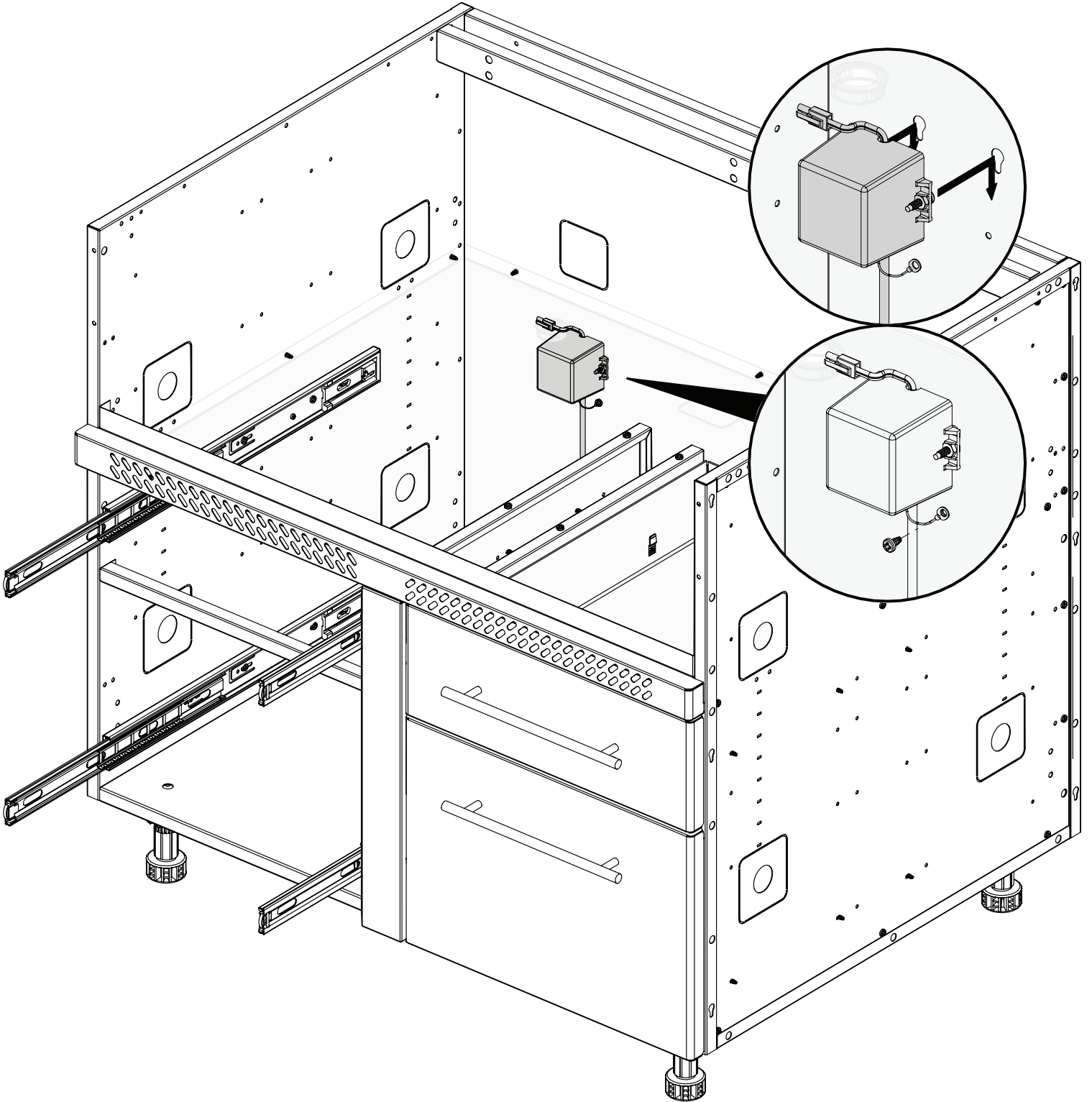

7

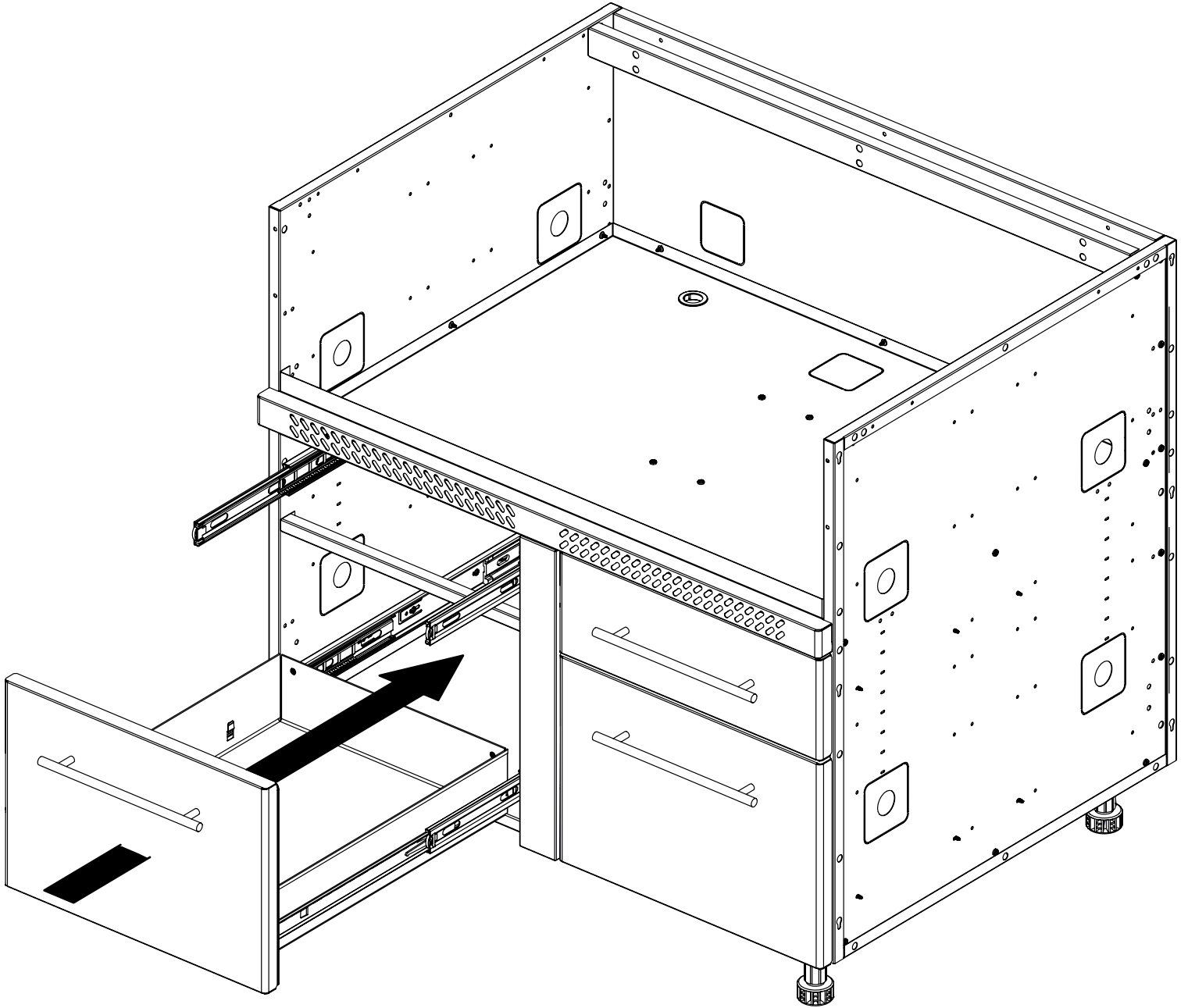

8

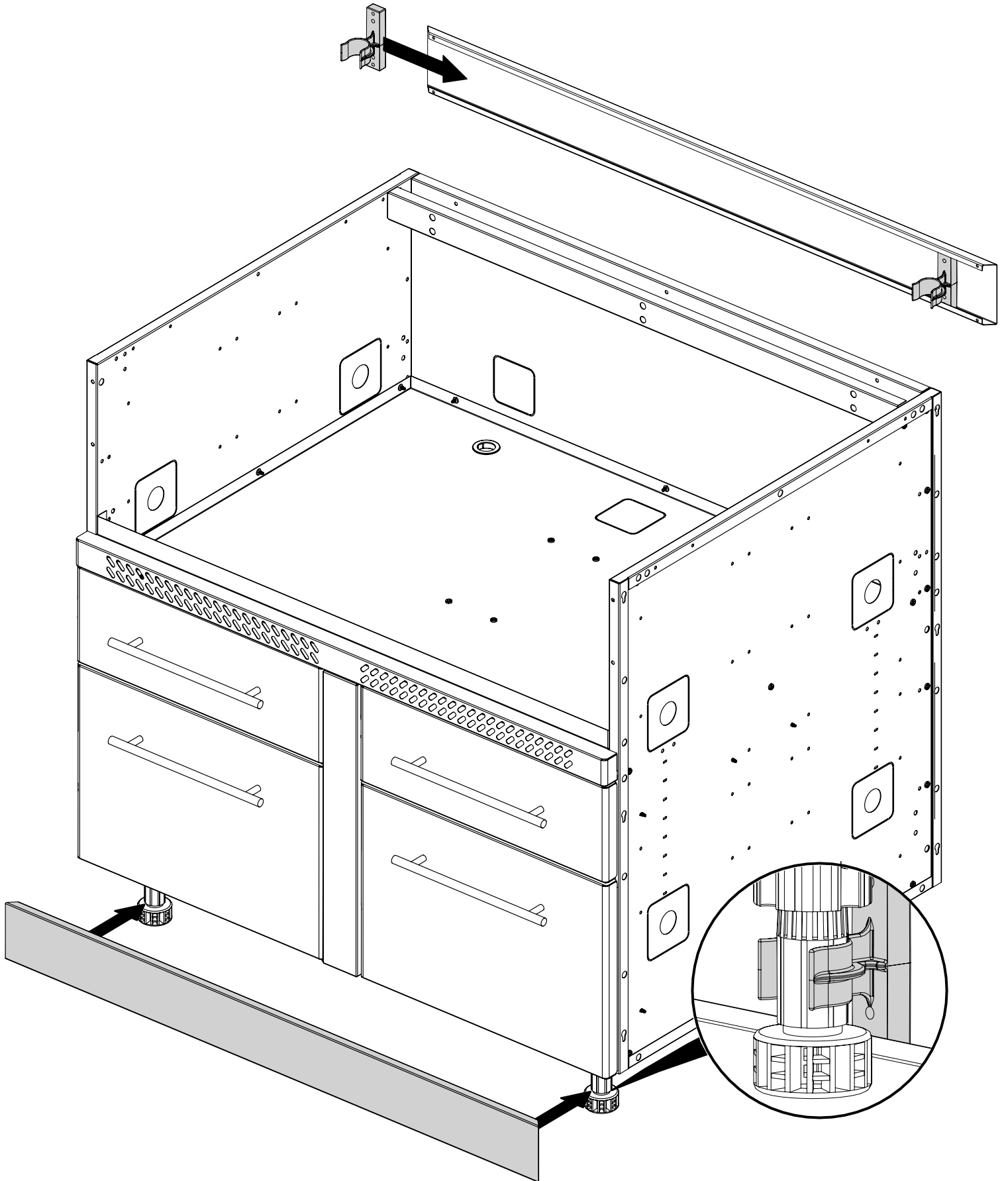

9

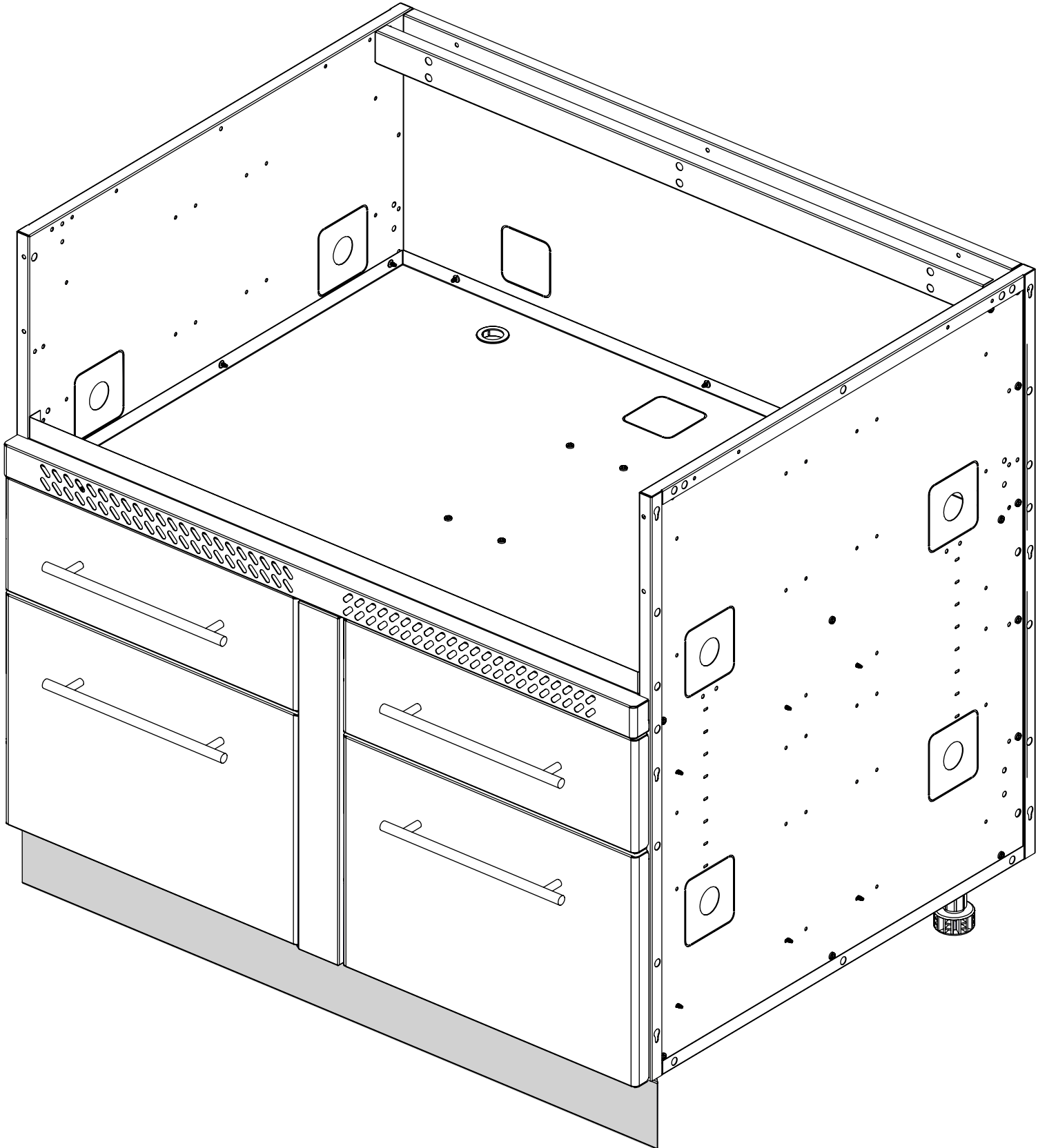

PARTS LIST / LISTE DES PIECES / LISTA DE PARTES

<u>KEY #</u>	<u>ITEM #</u>	<u>DESCRIPTION</u>	<u>DESCRIPTION</u>	<u>DESCRIPTION</u>	<u>806600</u>
1	71289-183	SIDE PANEL	PANNEAU LATÉRALE	PANEL LATERAL	2
3	71286-103	REAR PANEL	PANNEAU - ARRIÈRE	PANEL - POSTERIOR	1
7	71096-103	BASE	TABLETTE INFÉRIEURE	BASE	1
8	71031-103	DRAWER SUPPORT	SUPPORT	SOPORTE	2
9	71036-003	UPPER BRACE	SUPPORT SUPÉRIEUR	SUPPORT SUPÉRIEUR	1
10	71086-103	SEPARATION PANEL	DIVISEUR	DIVISOR	1
11	71639-103	CASTOR BRACKET	SUPPORT DE ROULLETTE	SOPORTE - PARA RUEDITA	2
12	71039-078	LEVELER BRACKET	TÊTE DE NIVELEUR À VISSER	CABEZA PARA NIVELADOR	4
13	71099-078	LEVELER LEG	NIVELEUR DE CAISSON	NIVELADOR	4
14	Y-99103	DRAWER SLIDE	GLISSIÈRE DE TIROIR	SOPORTE - CAJÓN	8
16	71069-103	DRAWER CENTER MOUNT	PLAQUE CENTRALE DE MONTAGE TIROIR	CENTRAL PLACA DE MONTAJE	2
17	71039-108	KICK PLATE LEG CLIP	ATTACHE POUR COUP-DE-PIED	GRAPA PARA NIVELADOR	2
18	71506-003	KICK PLATE	PLAQUE COUP-DE-PIED	RODAPIÉS	1
19	71530-163	KICK PLATE BRACKET	SUPPORT POUR PLAQUE COUP-DE-PIED	BASE PARA GRAPA	1
22	77061-113R	DRAWER	TIROIR	CAJÓN	4
24	71049-902	DRAWER GASKET	JOINT DE TIROIR	SELLO DE CAJÓN	2
25	77261-213	DRAWER INNER PANEL	PANNEAU INTÉRIEUR DE TIROIR	PANEL INTERIOR CAJÓN	2
26	77361-213	DRAWER OUTER PANEL	PANNEAU EXTÉRIEUR DU TIROIR	PANEL DE CAJÓN EXTERIOR	2
27	76100-933A	HANDLE	POIGNEE	MANGO	4
29	71236-103	FRONT FACIA	PANNEAU AVANT	PANEL FRONTAL	1
30	76039-103	CABINET CLAMP	PINCE DE CABINET	ALICATES PARA GABINETE	2
31	Y-11567	SCREW M8 SHOULDER	VIS M8	TOURNILLO M8	8
32	Y-29304S	SCREW #10-24 X 3/8	VIS #10-24 X 3/8	TOURNILLO #10-24 X 3/8	143
34	71206-113	FRONT FACIA	PANNEAU AVANT	PANEL FRONTAL	1
37	71049-903	DRAWER GASKET	JOINT DE TIROIR	SELLO DE CAJÓN	2
38	77261-223	DRAWER INNER PANEL	PANNEAU INTÉRIEUR DE TIROIR	PANEL INTERIOR CAJÓN	2
39	77361-223	DRAWER OUTER PANEL	PANNEAU EXTÉRIEUR DU TIROIR	PANEL DE CAJÓN EXTERIOR	2
40	Y-12220	BUSHING	DOUILLE	COJINETE	1

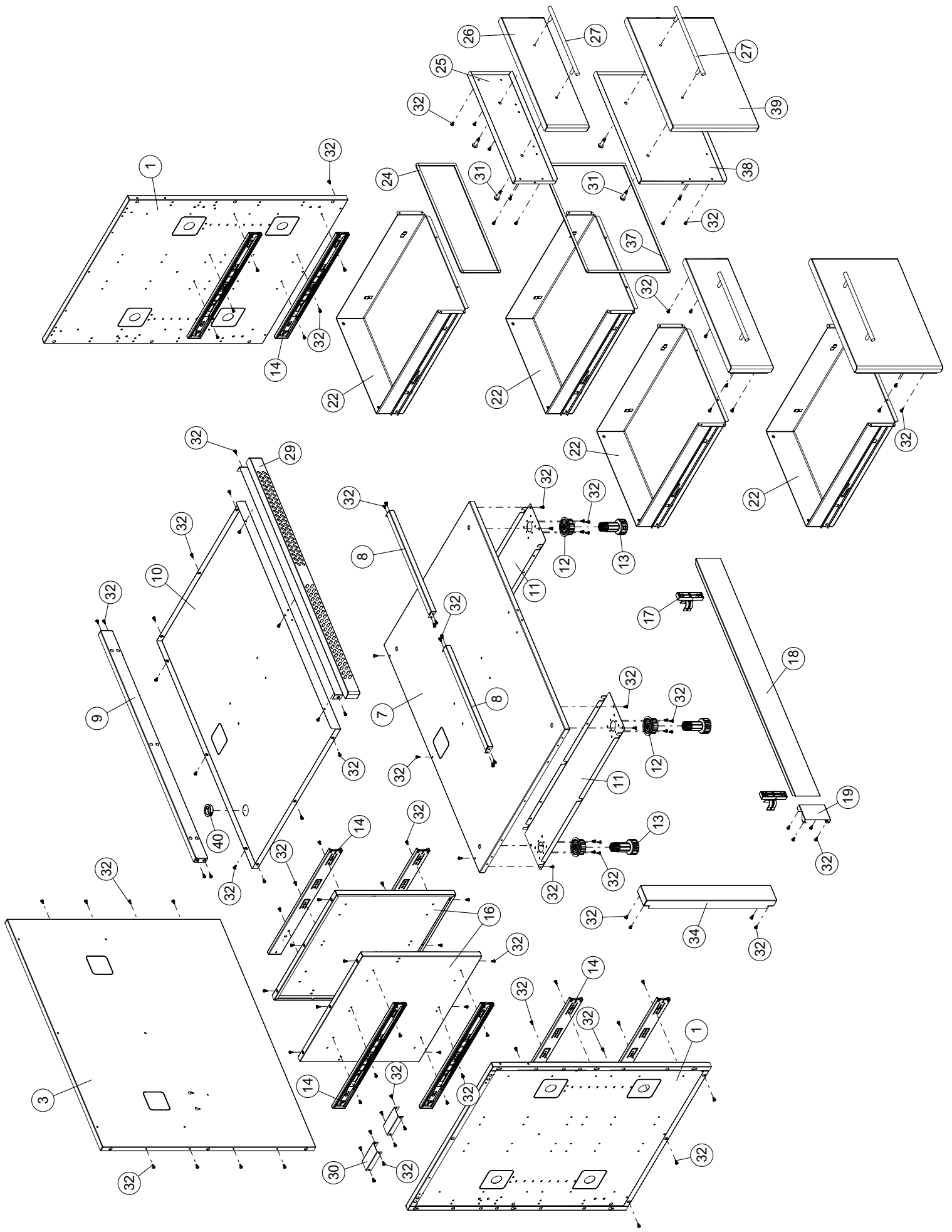

Broil King®



Onward
MANUFACTURING COMPANY LIMITED
SINCE 1906
585 KUMPF DRIVE
WATERLOO, ONTARIO, CANADA
N2V 1K3

1

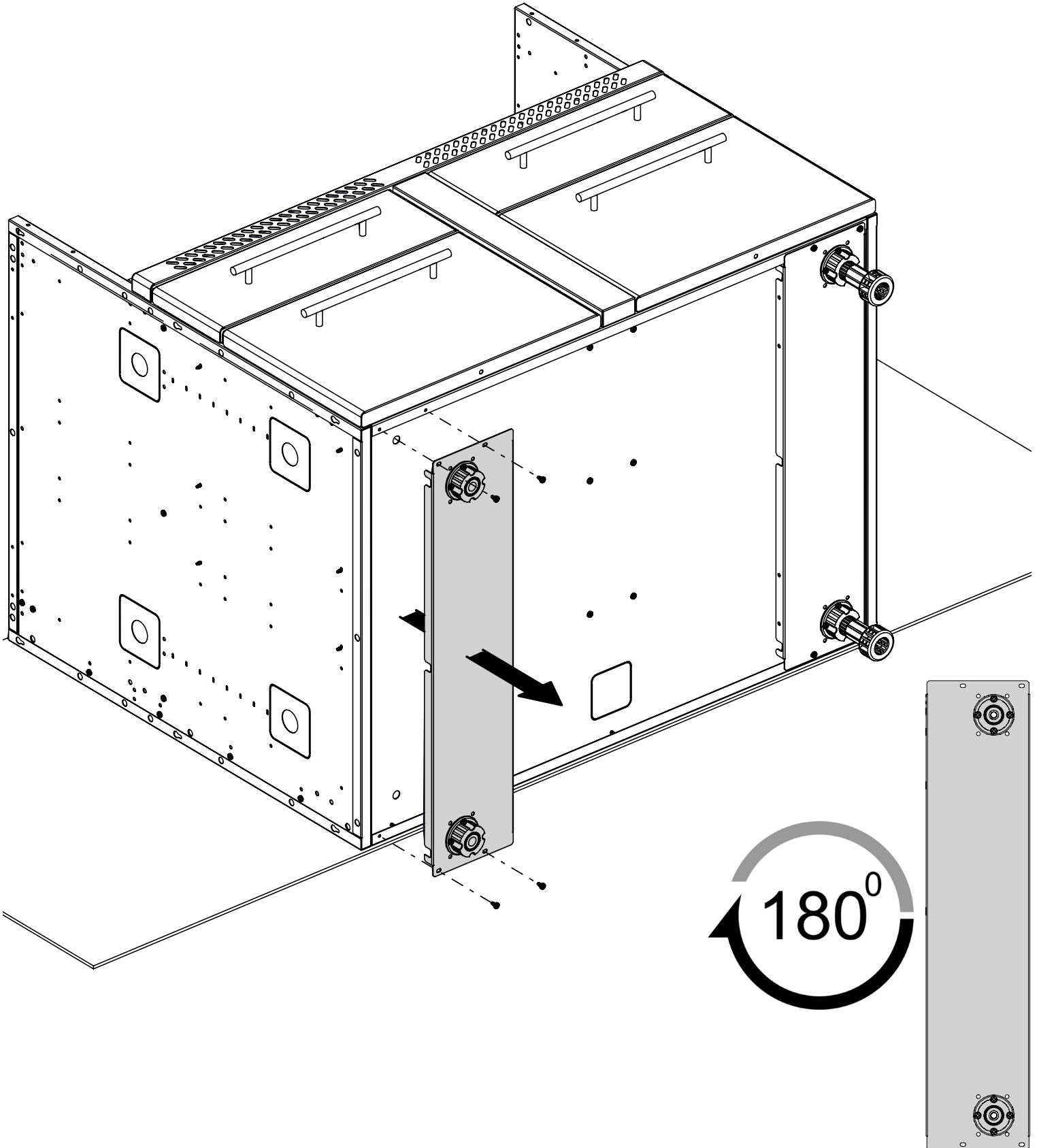

2

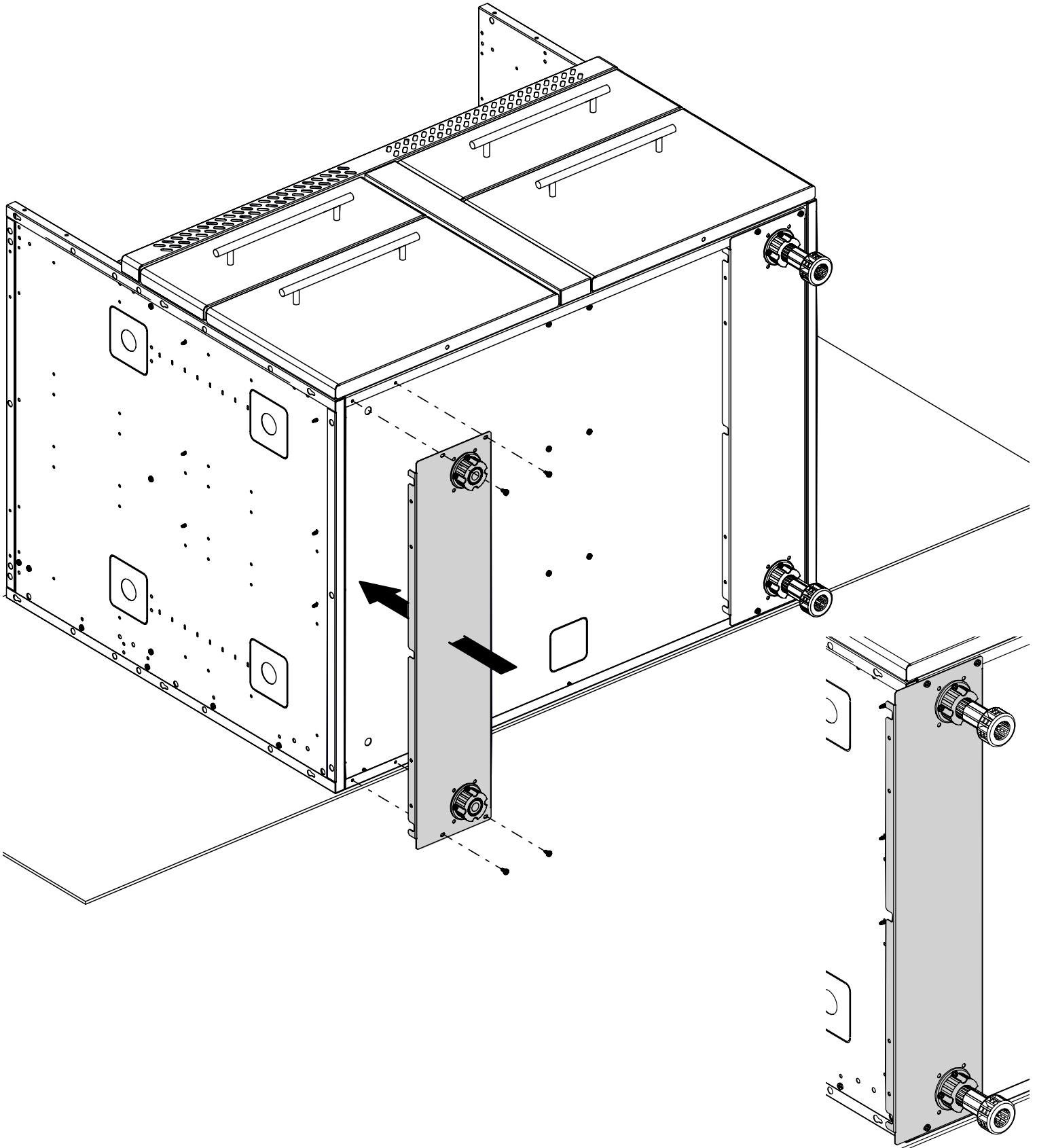

3

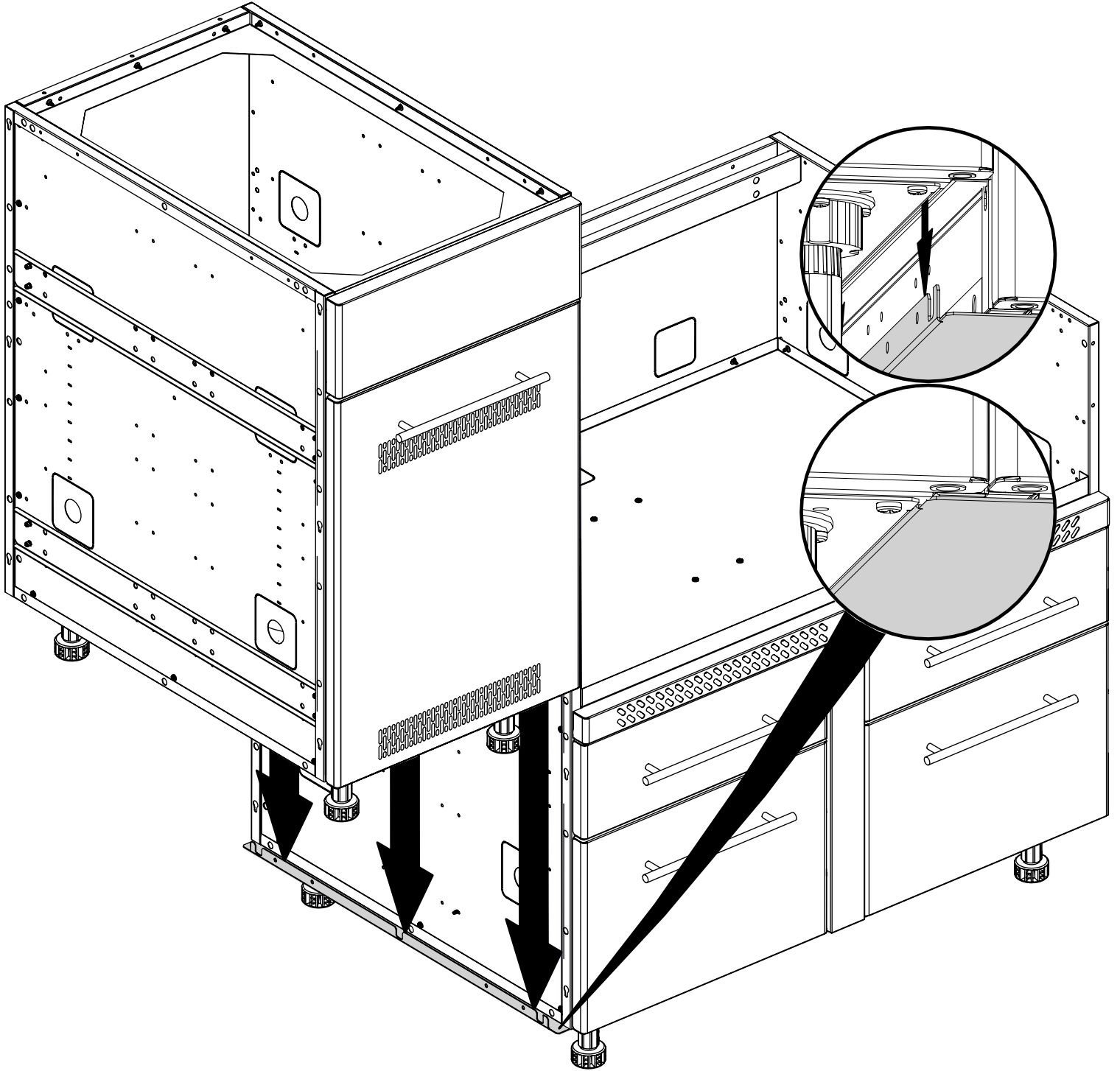

4

(8) 

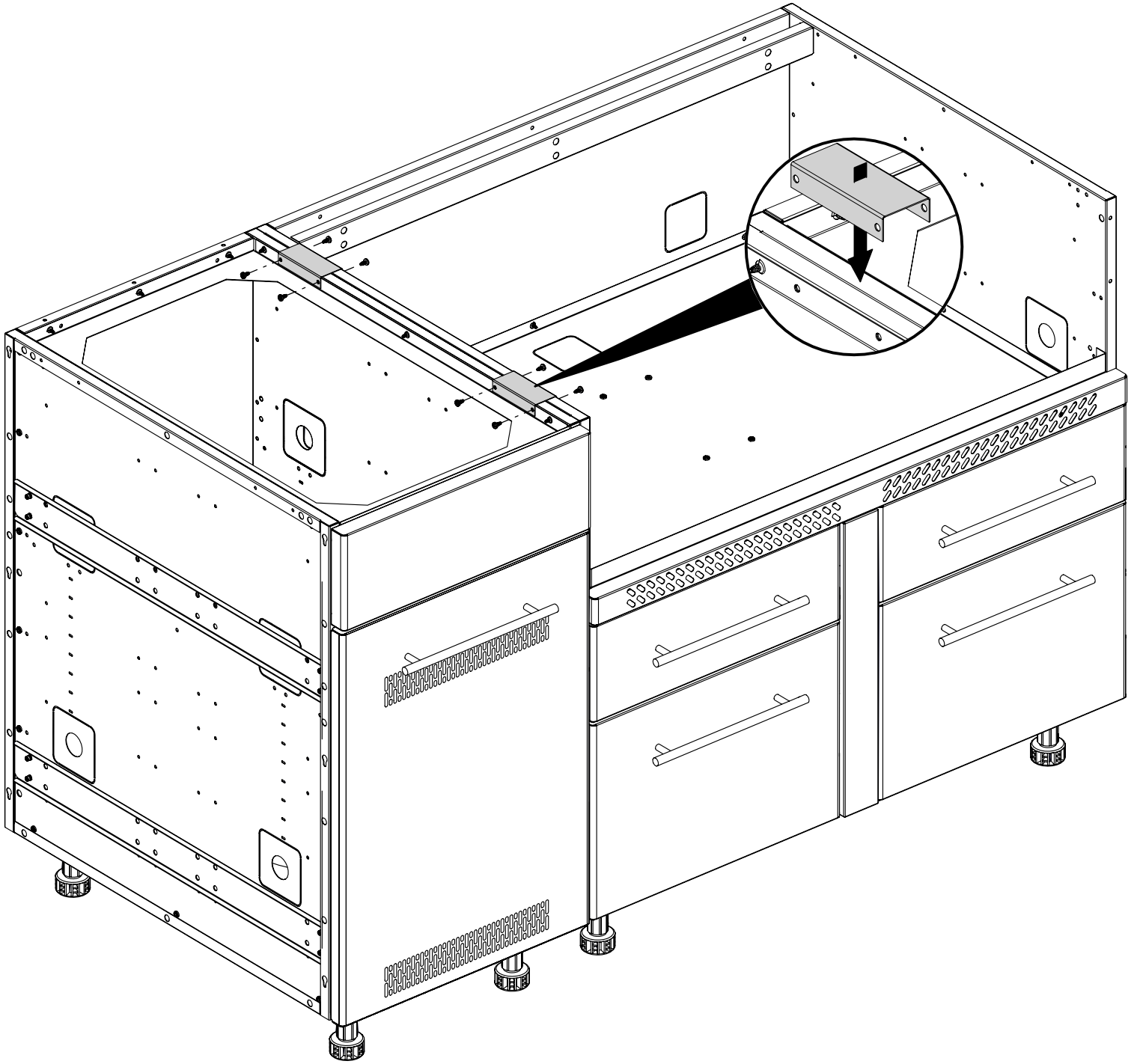

5

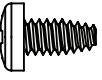
(4) 

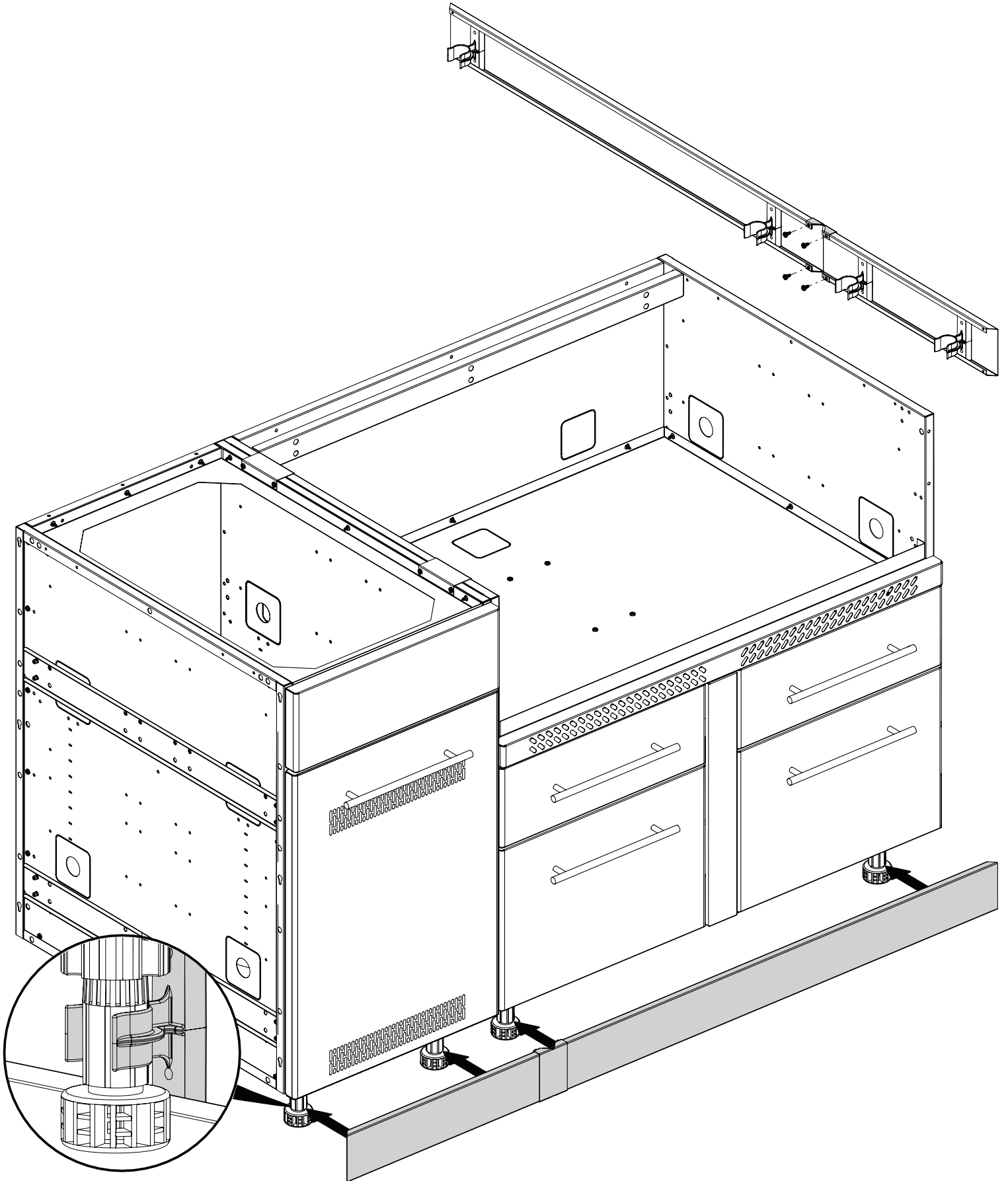

6

